

IPPCxxA7-RE Series

User Manual

2013 Oct V1

Copyright © 2013 IBASE Technology Inc. All Rights Reserved.

No part of this manual, including the products and software described in it, may be reproduced, transmitted, transcribed, stored in a retrieval system, or translated into any language in any form or by any means, except documentation kept by the purchaser for backup purposes, without the express written permission of IBASE Technology INC. (“IBASE”).

Products and corporate names mentioned in this manual may or may not be registered trademarks or copyrights of their respective companies, and are used for identification purposes only. All trademarks are the property of their respective owners.

Every effort has been made to ensure that the contents of this manual are correct and up to date. However, the manufacturer makes no guarantee regarding the accuracy of its contents, and reserves the right to make changes without prior notice.

Table of Contents

CHAPTER 1 INTRODUCTION	1
1.1 General Description	1
1.2 System Specification	2
1.2.1 Hardware Specifications	2
1.2.2 Dimensions	3
1.2.3 I/O View.....	5
1.3 Packing List.....	7
1.4 Installation	7
1.4.1 Installing the Panel Mount	7
1.4.2 Installing the VESA Mount	9
1.4.3 Installing the PCI module.....	10
1.4.4 Disassembly and Assembly of control box and display module	15
CHAPTER 2 MOTHERBOARD INTRODUCTION	18
2.1 Introduction	18
2.2 Installing the Memory	20
2.3 Setting Jumpers.....	21
2.4 Connectors	22
CHAPTER 3 BIOS SETUP	27
3.1 BIOS Introduction.....	27
3.2 BIOS Setup.....	27
3.3 Advanced Settings.....	29
3.4 Chipset Settings.....	38
3.5 Security Settings	45
3.6 Save & Exit Settings	46
CHAPTER 4 DRIVERS INSTALLATION	47
4.1 Intel Chipset Software Installation Utility	47
4.2 VGA Drivers Installation.....	48
4.3 Realtek HD Audio Driver Installation.....	49
4.4 LAN Drivers Installation	50
4.5 ALTERA FPGA Driver Installation.....	51

Safety Information

Your IPPC-xxA7-RE is designed and tested to meet the latest standards of safety for information technology equipment. However, to ensure your safety, it is important that you read the following safety instructions

Setting up your system

- Read and follow all instructions in the documentation before you operate your system.
- Do not use this product near water.
- Set up the system on a stable surface. Do not secure the system on any unstable plane.
- Do not place this product on an unstable cart, stand, or table. The product may fall, causing serious damage to the product.
- Slots and openings on the chassis are for ventilation. Do not block or cover these openings. Make sure you leave plenty of space around the system for ventilation. ***Never insert objects of any kind into the ventilation openings.***
- This system should be operated from the type of power indicated on the marking label. If you are not sure of the type of power available, consult your dealer or local power company.
- Use this product in environments with ambient temperatures between 0°C and 45°C.
- If you use an extension cord, make sure that the total ampere rating of the devices plugged into the extension cord does not exceed its ampere rating.
- DO NOT LEAVE THIS EQUIPMENT IN AN ENVIRONMENT WHERE THE STORAGE TEMPERATURE MAY GO BELOW -10° C OR ABOVE 60° C. THIS COULD DAMAGE THE EQUIPMENT. THE EQUIPMENT SHOULD BE IN A CONTROLLED ENVIRONMENT.

Care during use

- Do not walk on the power cord or allow anything to rest on it.
- Do not spill water or any other liquids on your system.
- When the system is turned off, a small amount of electrical current still flows. Always unplug all power, and network cables from the power outlets before cleaning the system.
- If you encounter the following technical problems with the product, unplug the power cord and contact a qualified service technician or your retailer.
 - The power cord or plug is damaged.
 - Liquid has been spilled into the system.
 - The system does not function properly even if you follow the operating instructions.
 - The system was dropped or the cabinet is damaged.

Lithium-Ion Battery Warning

CAUTION: Danger of explosion if battery is incorrectly replaced. Replace only with the same or equivalent type recommended by the manufacturer. Dispose of used batteries according to the manufacturer's instructions.

NO DISASSEMBLY

The warranty does not apply to the products that have been disassembled by users

WARNING

HAZARDOUS MOVING PARTS

KEEP FINGERS AND OTHER BODY PARTS AWAY

Acknowledgments

- AMI is a registered trademark of AMI Software International, Inc.
- AMD and ATI are registered trademarks of AMD Corporation.
- Microsoft Windows is a registered trademark of Microsoft Corporation.
- FINTEK is a registered trademark of FINTEK Electronics Corporation.
- REALTEK is a registered trademark of REALTEK Electronics Corporation.
- All other product names or trademarks are properties of their respective owners.

CHAPTER 1 INTRODUCTION

1.1 General Description

IPPC-xxA7-RE series is a fanless design panel pc, powered by Intel Atom processor D2550 1.86GHz and supporting 2 x SO-DIMM, up to 4GB DDRIII 1066MHz FSB, 4x USB connector, 1x COM Port, support 1x SATA HDD space, 1x PCI slot expansion, DC power 12V input etc. It is ideal for industrial automation, factory automation applications.



1.2 System Specification

1.2.1 Hardware Specifications

Model Name	IPPC-12A7-RE	IPPC-15A7-RE	IPPC-17A7-RE	IPPC19A7-RE
System Mainboard	IB806			
CPU	Intel Atom Process D2550 1M Cache, 1.86GHz			
Chipset	Intel NM10 Express Chipset			
Memory	2 x DDR3 1600MHz DIMM, Max. 16GB (Non-ECC)			
I/O Interface	2 x Gigabit LAN (RJ45) 4 x USB 2.0 (USB Host. A-Type) 1 x COM1 RS-232/422/485 1 x 12V DC-in 1 x VGA 1 x speaker-out microjack 1 x Mic-in microjack 1 x Digital I/O			
Storage	1 x 2.5" 320GB SATA HDD			
Expansion Slots	1 x PCI slot			
Power Supply	+ 12C DC-in, 84W power adaptor			
LCD Size	12" TFT LCD	15" TFT LCD	17" TFT LCD	19" TFT LCD
LCD Color	16.7M colors			
LCD Resolution	1024 x 768		1280 x 1024	
LCD Brightness	500 cd/m2	400 cd/m2	350 cd/m2	
LCD Viewing Angle	160(H)/160(V)		170(H)/170(V)	170(H)/160(V)
Backlight MTBF	50,000 hrs			
Touch Screen	Resistive Touch Panel			
Construction	Aluminum & SGCC		Aluminum & SPCC	
Mounting	Panel Mount / VESA Mount 75x75 and 100x100 mm			
Dimensions (W)x(H)x(D) mm	320 x 270 x 60.5	390 x 315 x 65.5	430 x 365 x 73	465 x 390 x 73
Operating Temperature	0°C ~ 45°C			
Storage Temperature	-10°C ~ 60°C		-20°C ~ 80°C	
Relative Humidity	5~90% @45°C (non-condensing)			
Protection Class	IP65 (Front panel with wall mount)			

•This specification is subject to change without prior notice.

1.2.2 Dimensions

IPPC12A7-RE

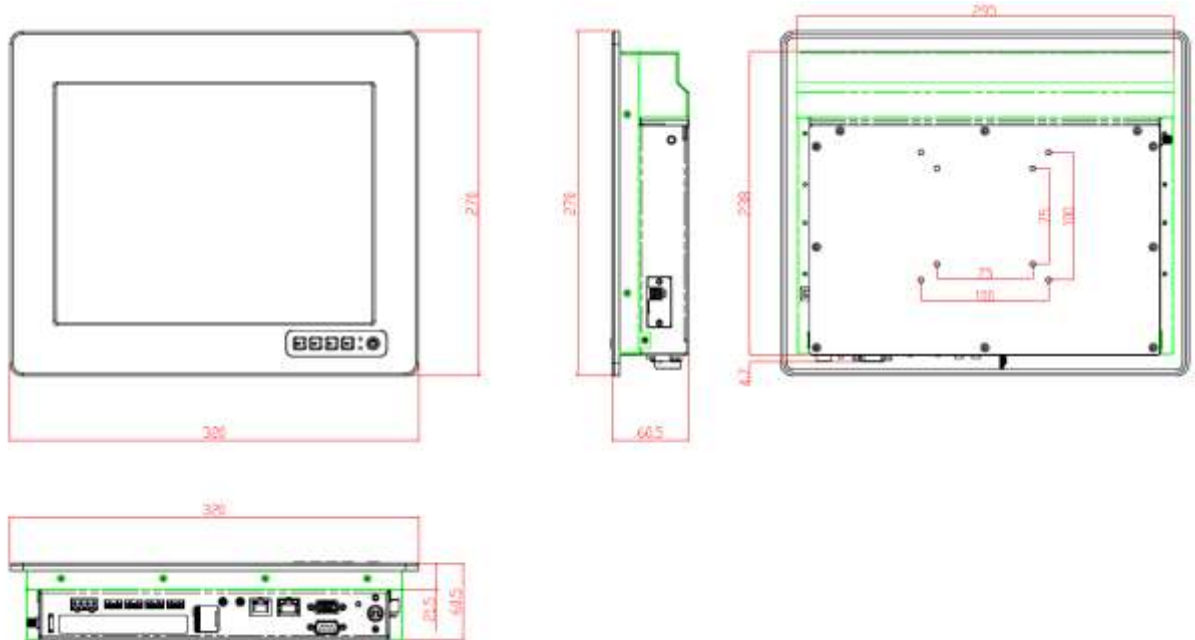

IPPC15A7-RE

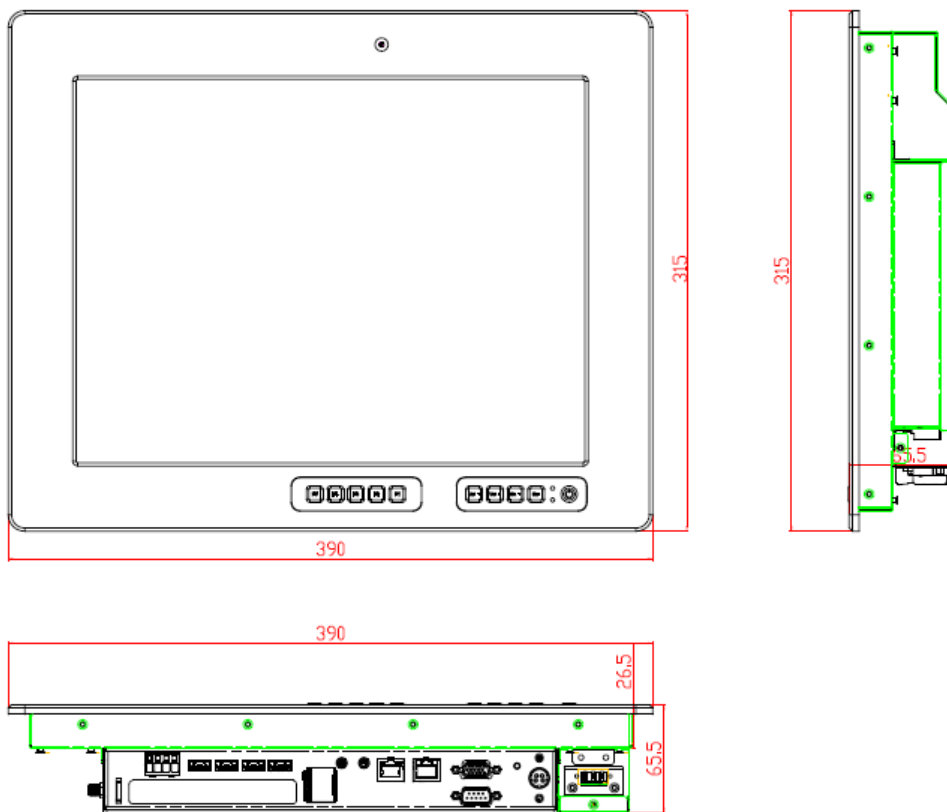

IPPC17A7-RE

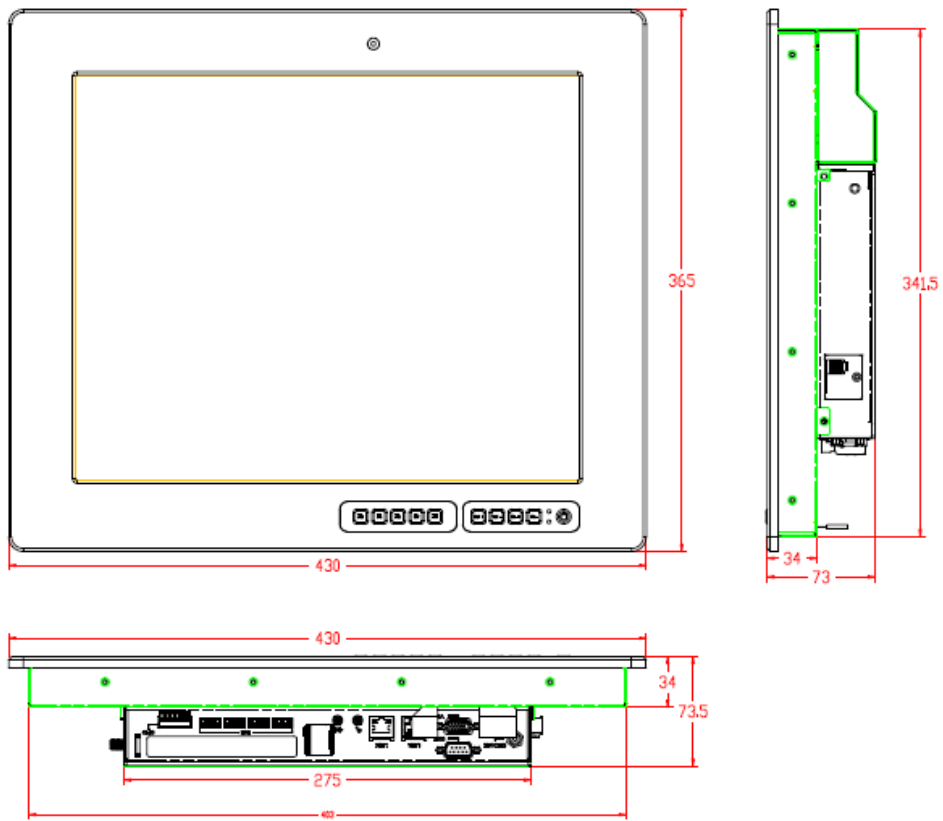

IPPC19A7-RE

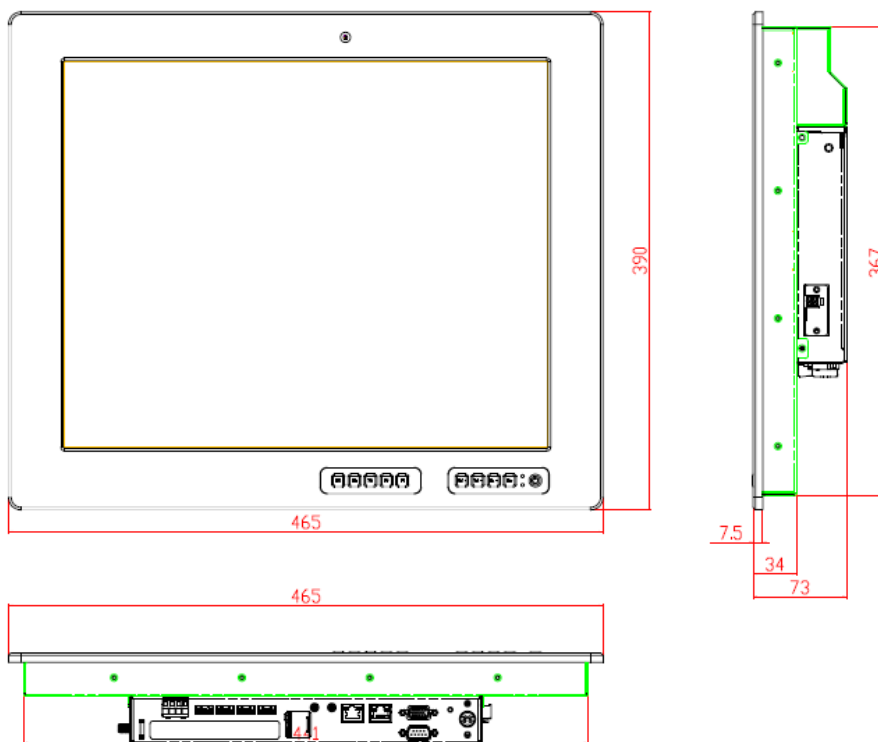

1.2.3 I/O View

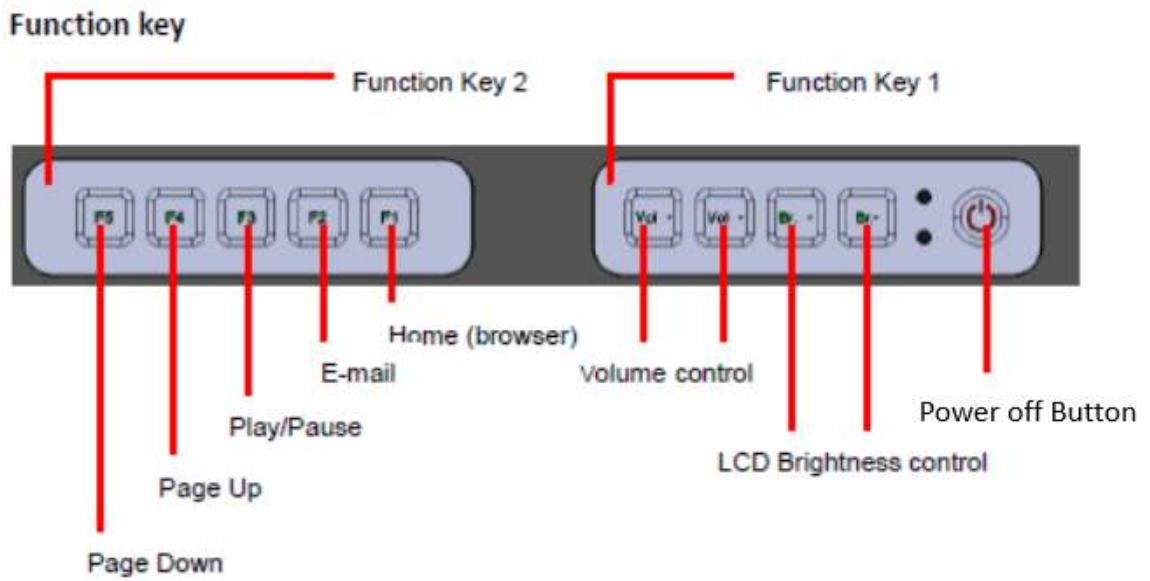
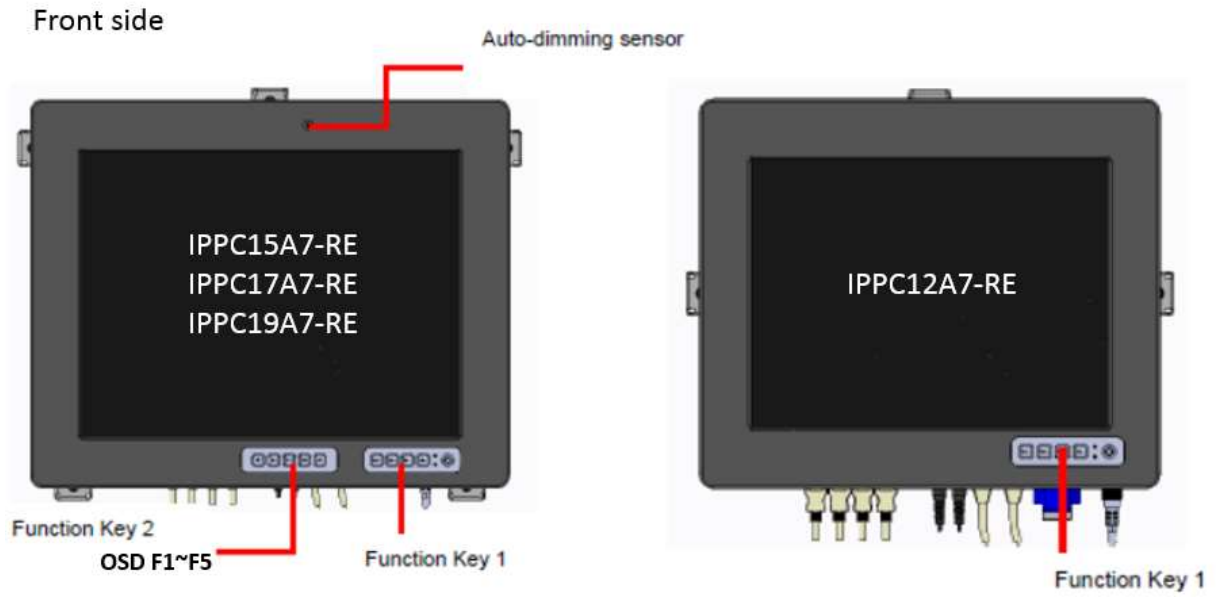

IO side

Refer to the diagram below to identify the components on this side of the system.

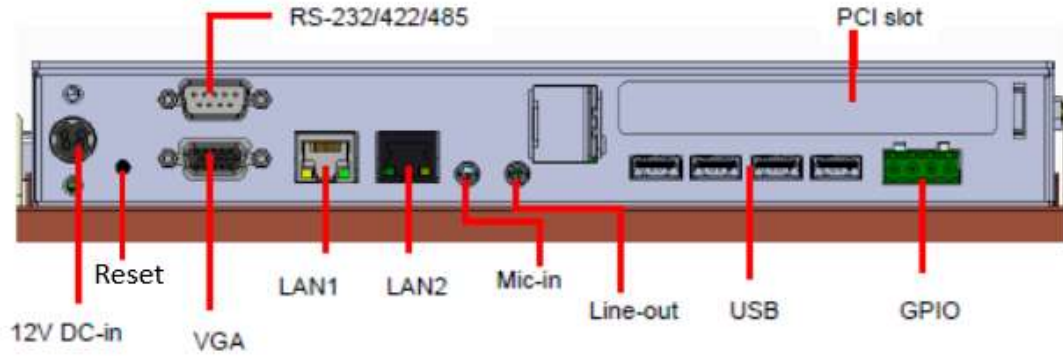

Top View

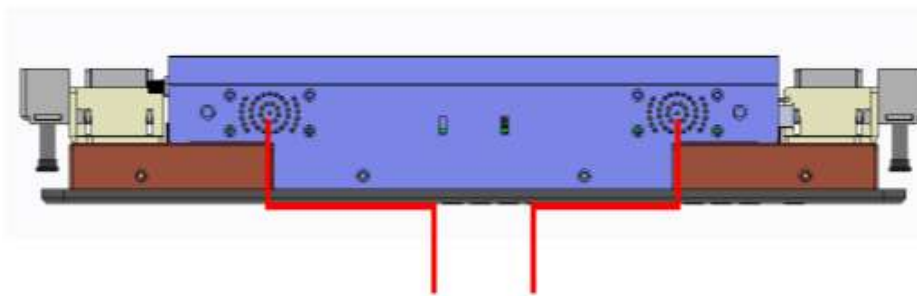

IPPC15A7-RE/IPPC17A7-RE/IPPC19A7-RE only

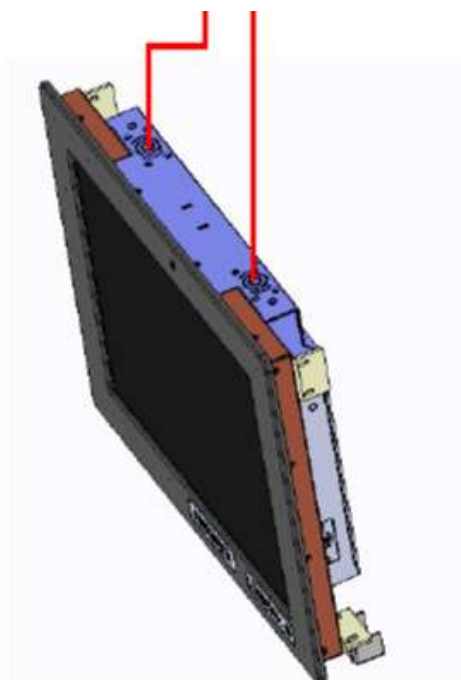

1.3 Packing List

Part NO.	Description	Qty
1	Driver CD	1 pc
2	Mounting Kits	1 set
3	Power Cord	1 pc

1.4 Installation

1.4.1 Installing the Panel Mount

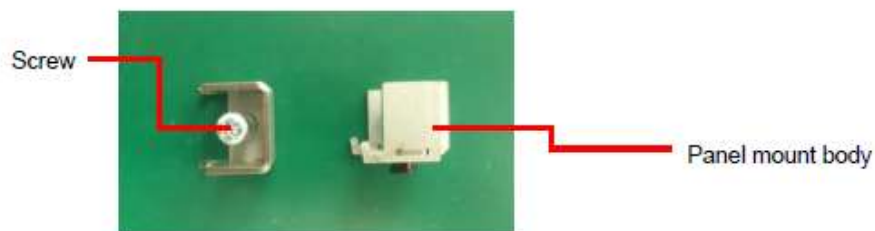

1. To assembly screw and panel mount body and put on the rubber cap at screw bottom as above picture.

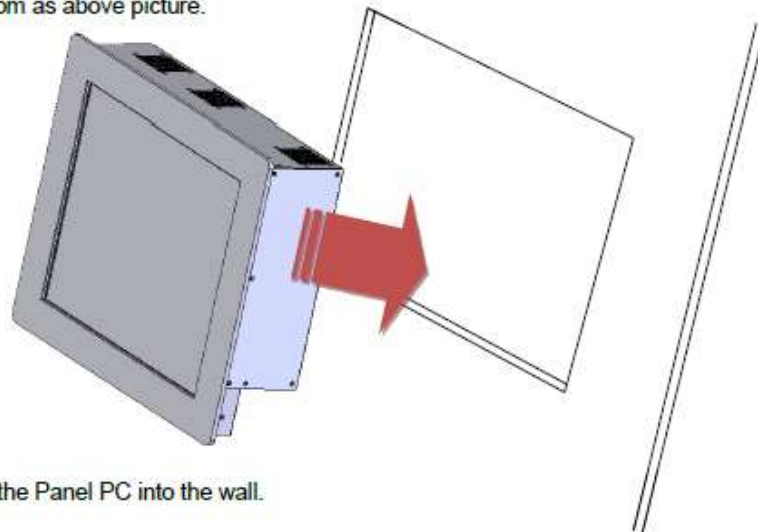

2. Put the Panel PC into the wall.

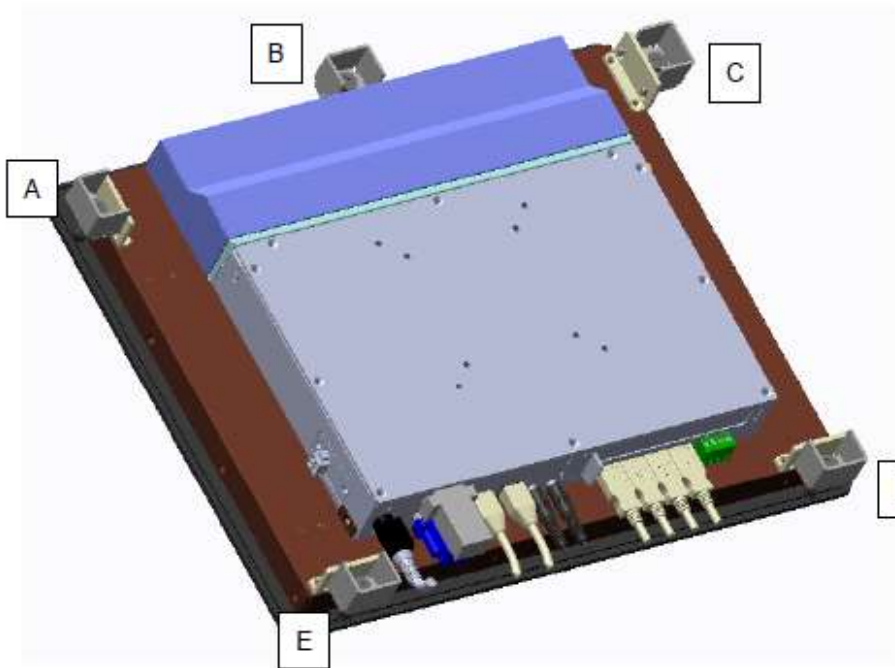

3. Put the panel mount from A to E



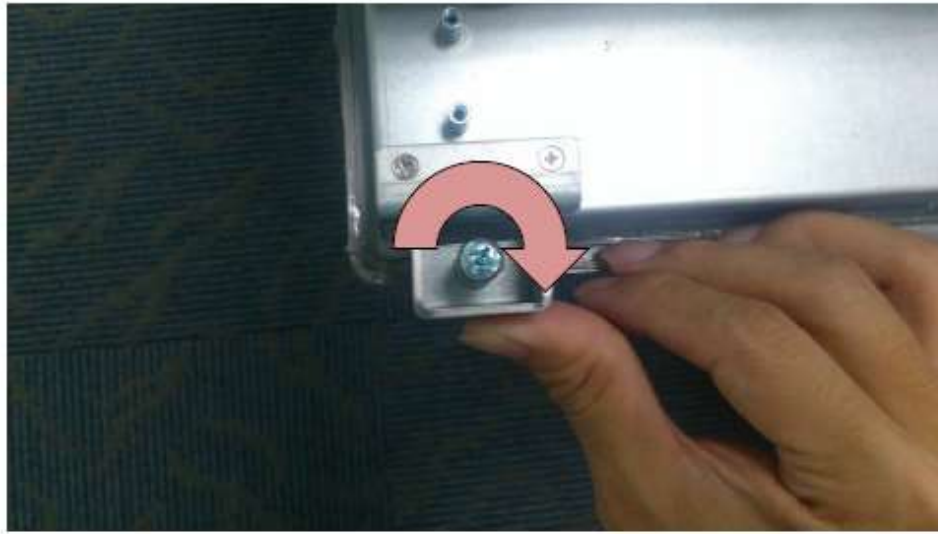

4. Lock the each screw of the panel mount.

1.4.2 Installing the VESA Mount

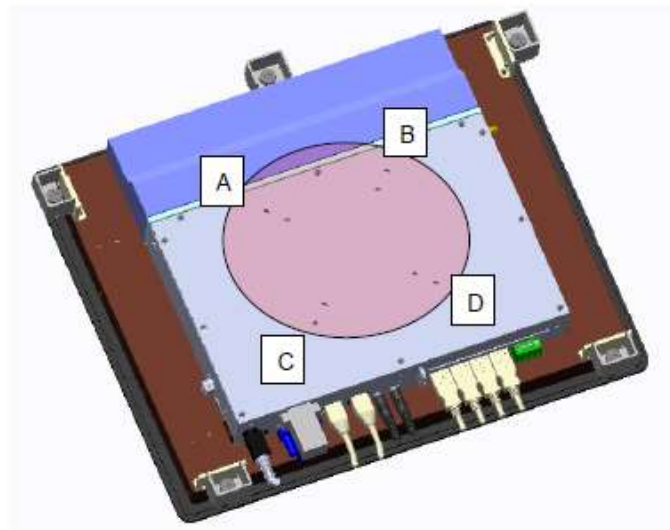

1. VESA mount of iBASE Panel PC is compatible with VESA stand 75x75 and 100x100
2. Put your VESA mount Kit on the Red Area.
3. Lock the screws from A to D.

1.4.3 Installing the PCI and WIFI module

1. Unlock and remove screws from point 1 to point 10
2. Remove the back cover (a Yellow part) from PPC controller.

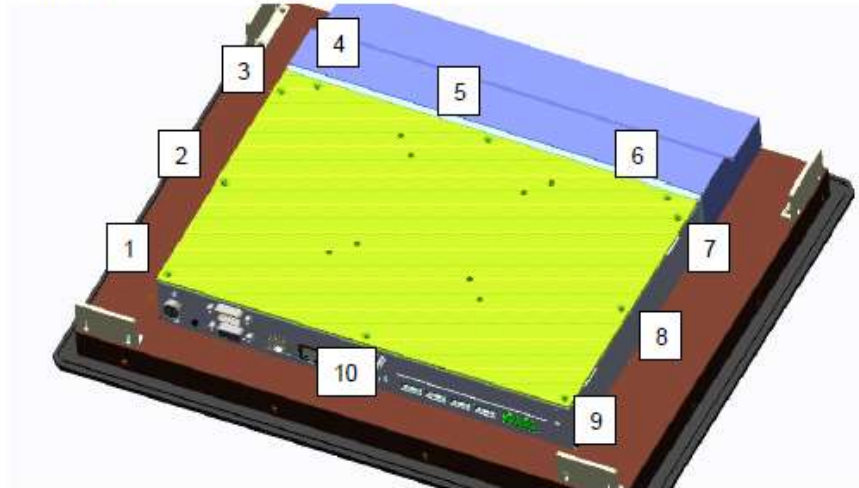

3. Unlock and Remove a screw from PCI slot cover.
4. Remove PCI cover and PCI cover bracket from inside.

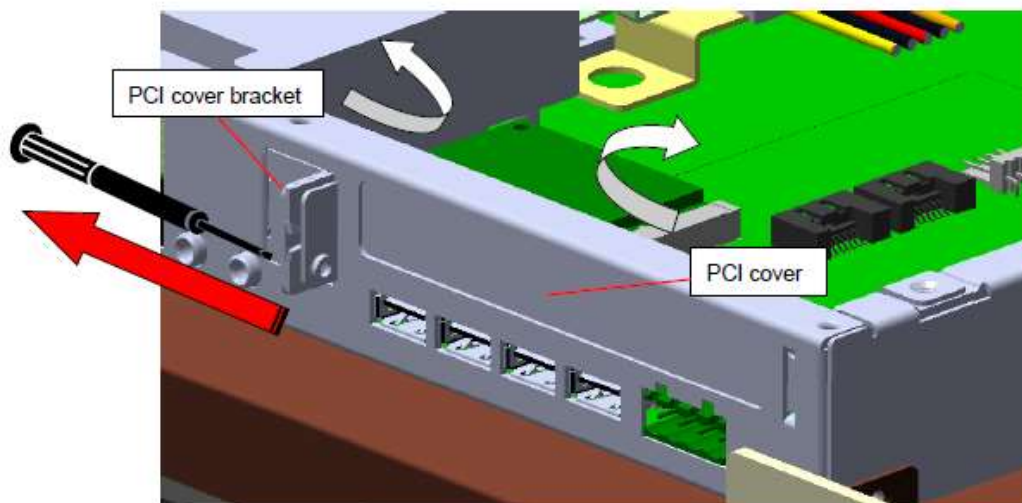

5. Install your PCI add-on card. (red circle are PCI slots)

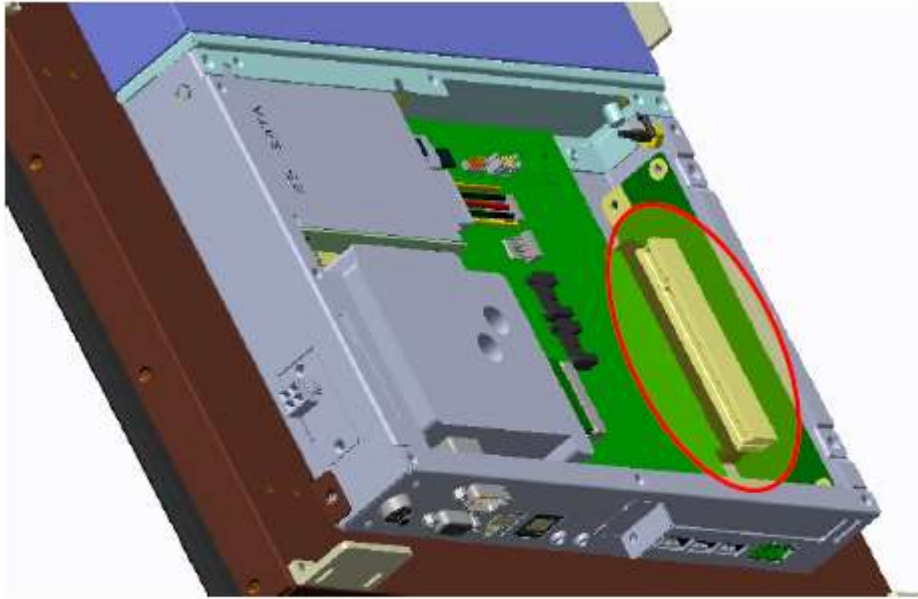

6. Put on the PCI cover bracket and lock the screw.

7. Put on the back cover and lock screws to finish the PCI add-on card installation.

8. Connect the WIFI internal antenna onto the WIFI module.



9. Push the WIFI module into the slot.



10. Use a screwdriver to turn the screw to its unlocked position.



11. Push the internal antenna into the position as picture.



12. Lock the screw as picture.



13. Connect the external antenna to its position as picture.



1.4.4 Disassembly and Assembly of control box and display module

Disassembly

1. Unlock and remove screws from point A and B

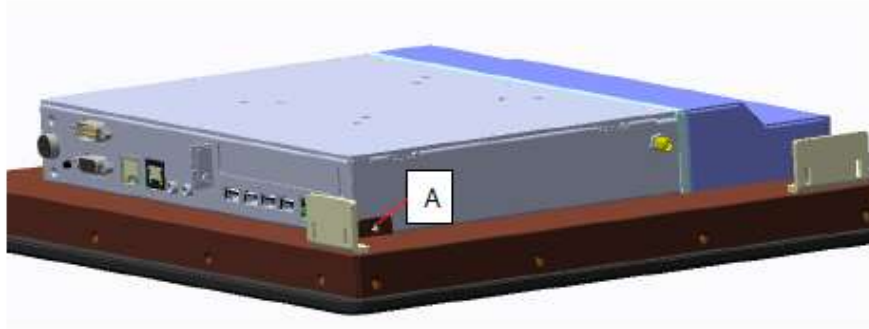

2. To slide the control box to the bottom and pull to up to remove the control box.

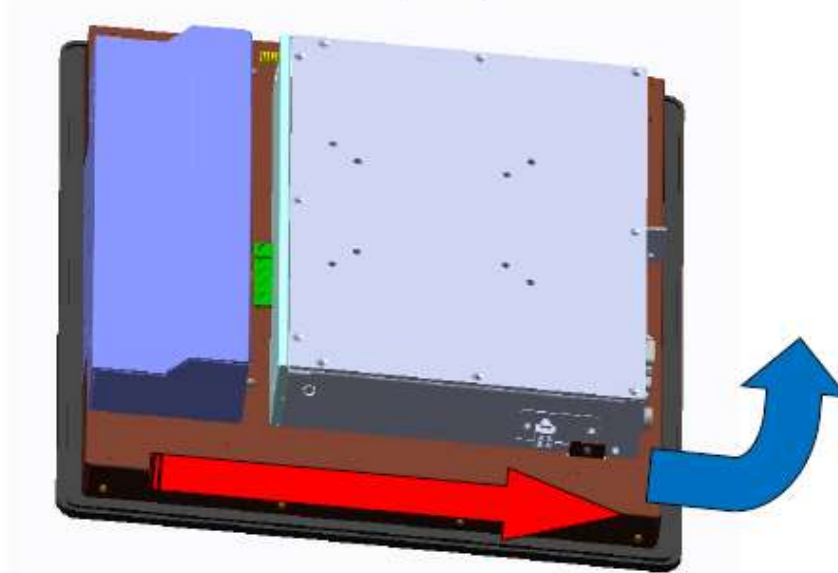

Assembly

1. To locate the adjusting pin with mounting hole of control box.

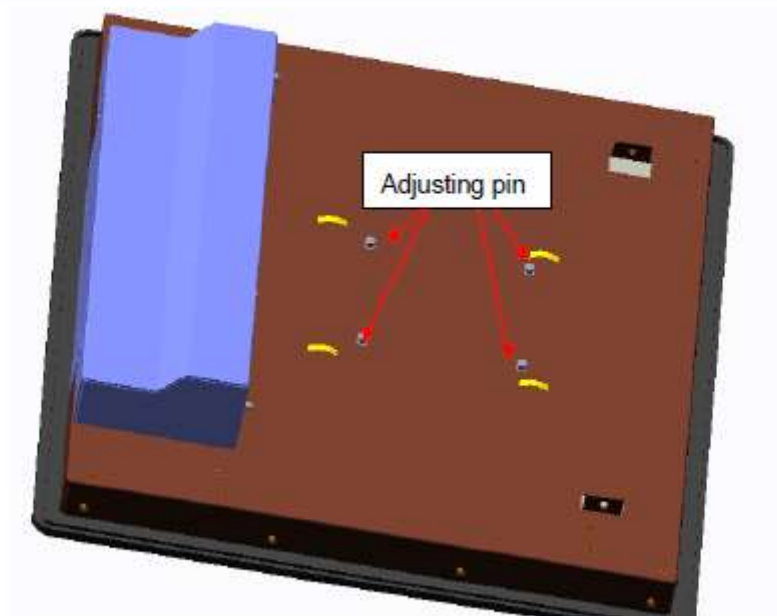
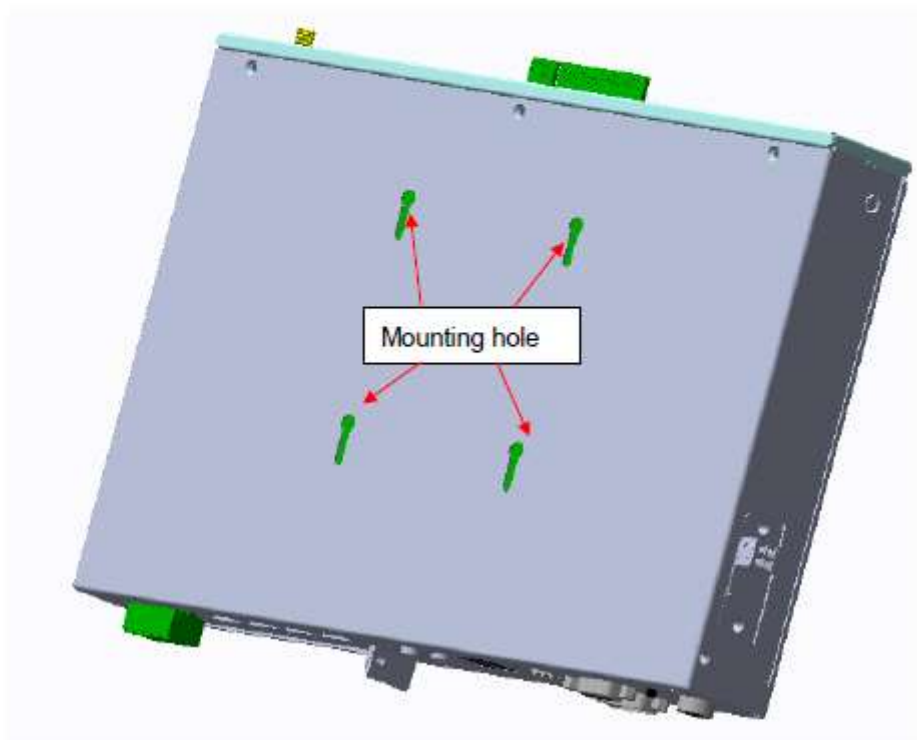

2. To push the control box to the top..

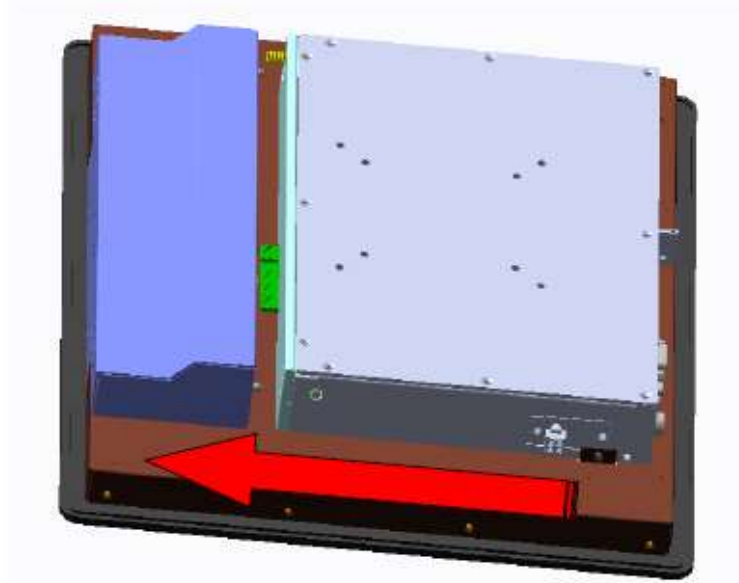

3. To lock point A and B screws.

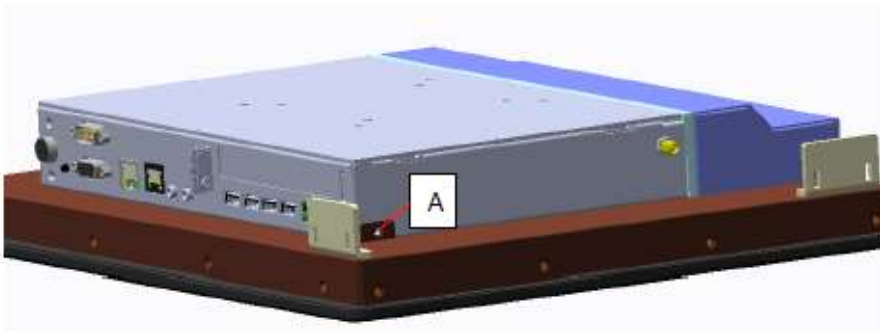

CHAPTER 2 MOTHERBOARD INTRODUCTION

2.1 Introduction

The IB806 Embedded Flex Motherboard is based on the Intel® Atom Cedarview chipset. Cedar Trail is a platform that uses the Intel Cedarview-D or Cedarview-M processor and Intel NM10 Express Chipset family in the desktop platforms.

The role of the processor in the system is to manage the flow of information between the following interfaces: DDR3 System Memory interface, DVI display interface, VGA graphics interface, Low Voltage Differential Signaling (LVDS) and the Direct Media Interface (DMI). The processor supports single channel, one DDR3 SODIMMs. The Intel® processors provide advanced performance in both computing and graphics quality. This meets the requirement of customers in the gaming, POS, digital signage and server market segment.

The processor is built on 32-nanometer Hi-K process technology with Micro-FCBGA11 packaging. Dimensions of the board are 190mm x 110mm.

Specifications – Mainboard	
Model	IB806
Form Factor	Customized
CPU Type	Intel® “Cedar view” Processor, 32nm Bulk Atom™ D2500 [TDP= 10W] Package = FCBGA Type[22 mm x 22 mm] Cores / Threads = 2/2 [D2500]
CPU Speed	1.86GHz for D2500
Cache	1MB
CPU Socket	BGA437 @ component side
Chipset	Intel® “Tiger Point” NM10 PCH, CG82NM10 [TDP = 2.1W, 130nm] Package = BGA360, 17mm x 17 mm
BIOS	AMI BIOS, support ACPI Function
Memory	DRAM: Intel® Atom TM on-die memory controller supporting up to 4GB One DDR3-1066 SO-DIMM socket [Horizontal type], Non-ECC, Unbuffered, 1.5V SRAM: CPLD EPM1270 + ST M40SZ100W x 4 SRAM 2Mb Battery: CR2450
LVDS	24-bit single channels LVDS interface w/PCIEx8 golden finger
VGA	Support DirectX 10.1 / OpenGL 3.0 IGP DB15 connector for VGA
LAN	Realtek® 8111E (GbE) as 1st LAN Realtek® 8111E (GbE) as 2nd LAN
Audio	Intel® NM10 PCH built-in HD Audio controller + Realtek ALC662 Codec w/class-D speaker amplifier (2.3W per channel @ 5V power supply) [7mm x 7mm @ 48-QFN] ; support 2-channel audio out + amp

USB	Intel® NM10 PCH integrated USB 2.0 host controller: 1. 4 ports in the rear panel 2. 1 port via onboard Mini-PCIE 3. 2 ports via edge golden-finger for connecting with ID910 4. 1 ports via edge golden-finger for connecting with IP930 **Total 8 x USB 2.0 ports**
LPC I / O	Nuvoton NCT6627UD [128-pin QFP, 14x14x1.4mm] - COM #1 (RS232/422/485 jumper-less) support ring-in with power @500 mA (selectable for 5V or 12V) - COM #2 (RS232 only) support ring-in with power @500 mA (cable selectable by pin#9 or pin#10 for 5V or 12V) via onboard pin-header - COM #3(TTL for MCU usage) thru golden finger to expansion module (ID910) - COM #4 (TTL for daughter board usage) thru golden finger to expansion module [Hardware Monitor] 2x Thermal inputs; 2x Voltage monitoring
Expansion Slot	Mini PCI-e socket x 1, Full-sized type, reserved one mounting hole for half-sized type, [USB device support]
Digital IO	2 in & 2 out with 5V Vcc 0.5A and GND [thru edge connector @ 1x6 pins Terminal block type] Connector type Dinkle ECH350R-06P
Edge Connector	VGA DB15 connector, DB9 1 for COM1 Digital I/O connector @ 1x6 pin type RJ45 x2 for GbE LAN, USB 2.0 connector x 4 for USB1~4 Line-out microjack, Mic-in microjack x 1
Onboard Header/Connector	2 ports x SATA II 4-pin power connector x2 for SATA HDD 2x5-pin box header for COM #2 2x5-pin header for LPC (Debug purpose only) Mini PCI-e(1x) connector [Full-sized] 5-pin box header for smart battery interface 2x2-pin power connector, 2x2-pin power vertical type connector 1x power button
Watchdog Timer	Yes (256 segments, 0, 1, 2...255 sec/min)
Power management	MSP430G2433
Power Connector	+12V DC-in only for AT/ATX mode
RoHS	Yes
Golden Finger	A. PCIE(x16) golden finger x 1 for connecting with IP930 Including the signals below: - PCIe(1x) x1, PCI x1, COM(TTL) x1, USB 2.0 x 1 - 12V 4A power, 5V 2A, 3.3V 2A **Each pin for PCI-express is 1A** B. PCIE(8x) for ID910 board - COM (TTL) x1, USB 2.0 x2, 24-bit LVDS, DVI x1 - PWR button x1, Reset button x1, LED signal HDD x1 - Audio x1, Audio detect pin for AMP x1 - 12V 4A power, 5V 4A power, 3.3V 4A power - SCI x1

Board Dimensions

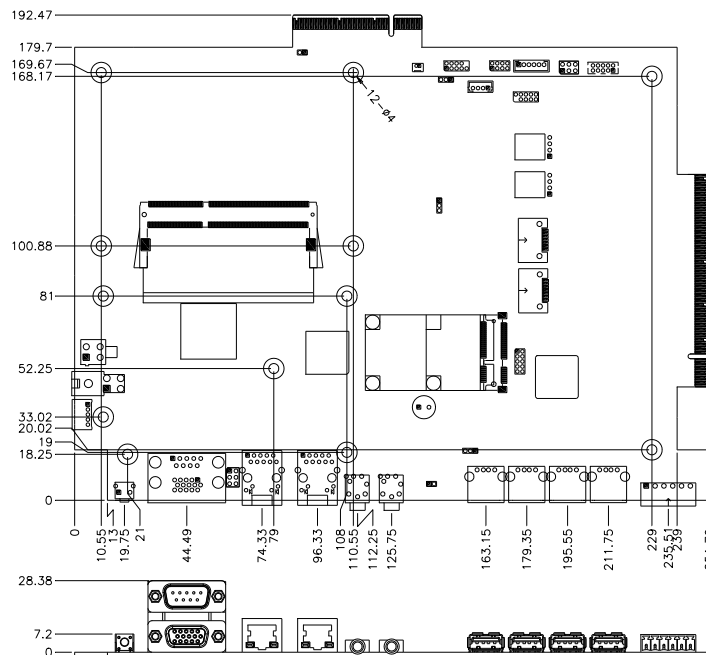

2.2 Installing the Memory

The IB806 board supports two DDR3 memory socket for a maximum total memory of 2GB in DDR3 memory type.

Installing and Removing Memory Modules

To install the DDR3 modules, locate the memory slot on the board and perform the following steps:

1. Hold the DDR3 module so that the key of the DDR3 module aligned with that on the memory slot.
2. Gently push the DDR3 module in an upright position until the clips of the slot close to hold the DDR3 module in place when the DDR3 module touches the bottom of the slot.
3. To remove the DDR3 module, press the clips with both hands.

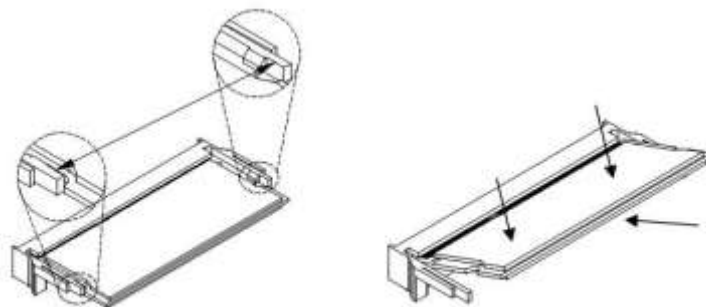

2.3 Setting Jumpers

Jumpers are used on IB806 to select various settings and features according to your needs and applications. Contact your supplier if you have doubts about the best configuration for your needs. The following lists the connectors on IB806 and their respective functions.

Jumper Locations on IB806

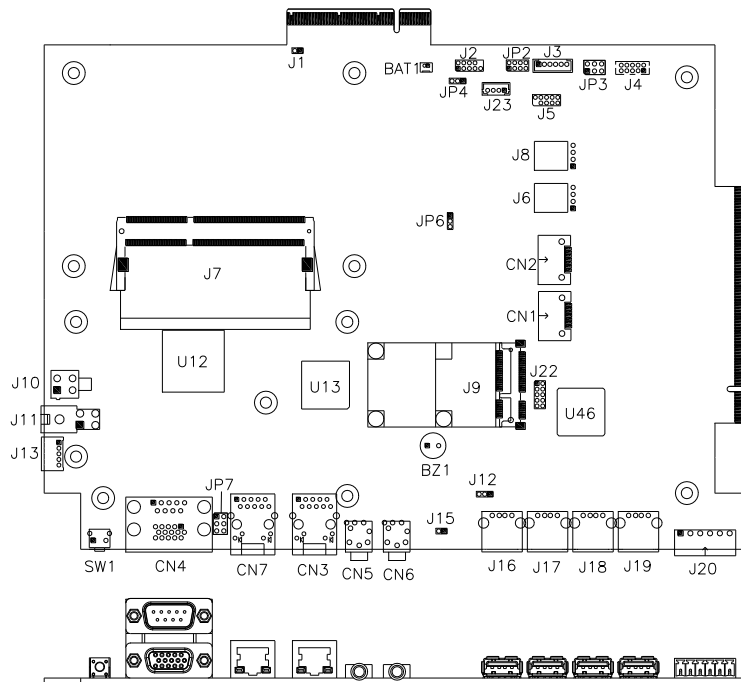



JP7, JP3: COM1, COM2 RS232 RI/+5V/+12V Power Setting

JP7, JP3	Setting	Function
	Pin 1-2 Short/Closed	+12V
	Pin 3-4 Short/Closed	RI
	Pin 5-6 Short/Closed	+5V

Note: The suggested setting is RI, with maximum current lower than 1A.

JP4: Clear CMOS Contents

JP4	Setting	Function
	Pin 1-2 Short/Closed	Normal
	Pin 2-3 Short/Closed	Clear CMOS

2.4 Connectors

Connector Locations on IB806

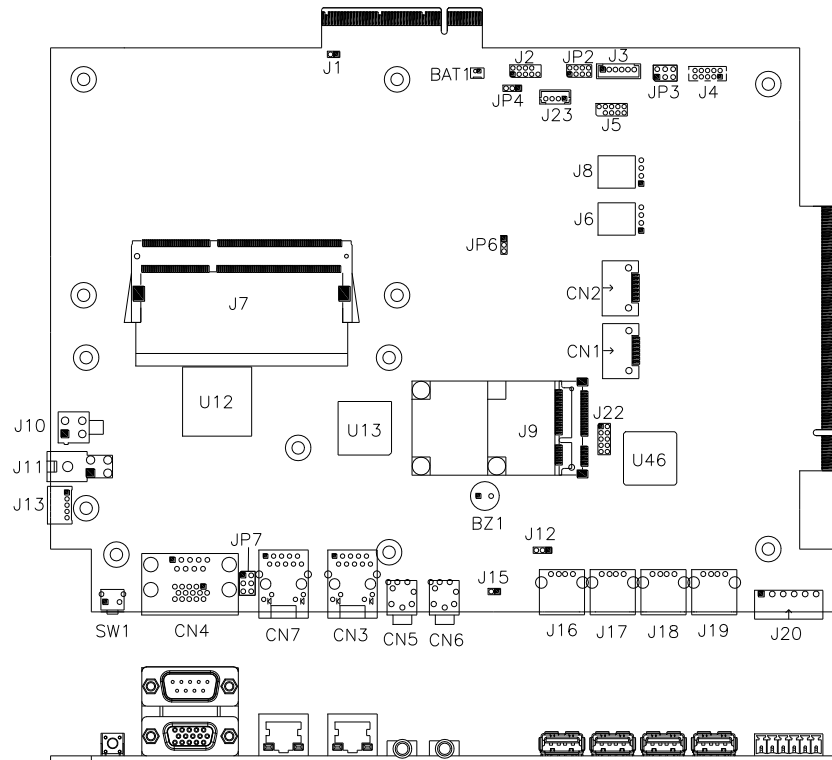

CN1, CN2: SATA Connector

CN3: Gigabit LAN (RTL8111E-VL)

This RJ45 LAN connector features for EUP LAN wakeup.

CN4: DB9+CRT Connector

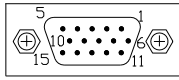

Signal Name	Pin #	Pin #	Signal Name
Red	1	2	Green
Blue	3	4	N.C.
GND	5	6	GND
GND	7	8	GND
VCC	9	10	GND
N.C.	11	12	DDCDATA
HSYNC	13	14	VSYNC
DDCCLK	15		

(COM1) is a DB-9 connector.

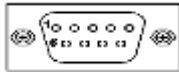

Signal Name	Pin #	Pin #	Signal Name
DCD, Data carrier detect	1	6	DSR, Data set ready
RXD, Receive data	2	7	RTS, Request to send
TXD, Transmit data	3	8	CTS, Clear to send
DTR, Data terminal ready	4	9	RI, Ring indicator
GND, ground	5	10	Not Used

COM1 is jumper-less for RS-232, RS-422 and RS-485 and configured with BIOS Selection.

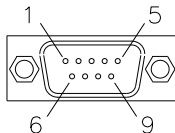

Pin #	Signal Name		
	RS-232	R2-422	RS-485
1	DCD	RX+	DATA-
2	RX	RX-	DATA+
3	TX	TX+	DATA-
4	DTR	TX-	DATA+
5	Ground	Ground	Ground
6	DSR	NC	NC
7	RTS	NC	NC
8	CTS	NC	NC
9	RI	NC	NC
10	NC	NC	NC

CN5: Mic Phone-Jack Connector

CN6: Line-out Phone-Jack Connector

CN7: Gigabit LAN (RTL8111E-VL)

This RJ45 LAN connector features for LAN wakeup.

J2: Debug 80 Port Connector (factory use only)

J3: Digital I/O 2in/2out Connector

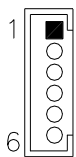

Pin #	Signal Name
1	Out2
2	Out3
3	In2
4	In3
5	VCC
6	GND

J4: COM2/RS232 Serial Port



Signal Name	Pin #	Pin #	Signal Name
DCD, Data carrier detect	1	2	RXD, Receive data
TXD, Transmit data	3	4	DTR, Data terminal ready
GND, ground	5	6	DSR, Data set ready
RTS, Request to send	7	8	CTS, Clear to send
RI, Ring indicator	9	10	Not Used

J5: SPI Flash Connector (Factory use only)

J6, J8: SATA HDD Power Connector



Pin #	Signal Name
1	+5V
2	Ground
3	Ground
4	+12V

J7: DDR3 SO-DIMM Socket**J9: Mini PCIE Connector****J10, J11: 12V Power Connector**

This connector supplies the CPU operating voltage.

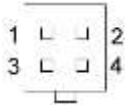

Pin #	Signal Name
1	Ground
2	Ground
3	+12V
4	+12V

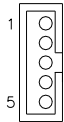
J13: Smart Battery Interface Connector

Pin #	Signal Name
1	RST
2	EXTSMI
3	Ground
4	DATA
5	CLK

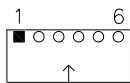
J16, J17, J18, J19: USB2.0 Connectors**J20: Digital I/O 2in/2out Connector**

Pin #	Signal Name
1	Out0
2	Out1
3	In0
4	In1
5	VCC
6	GND

J22: SRAM CPLD Flash Connector (factory use only)**J23: MCU Flash Connector (factory use only)**

JP2: Front Panel Connector

The following table shows the pin outs of the 2x4 pin header

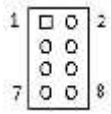

Signal Name	Pin #	Pin #	Signal Name
Ground	1	2	PWR_SW
PWR_LED+	3	4	PWR_LED-(GND)
HDD_LED+	5	6	HDD_LED-
Ground	7	8	RESET

PCIE1: PCIe8 Goledn Finger

(Includes DVI, USBx2, COMx1, LVDS Single Channel 24bit Signal)

PCIE2: PCIe16 Goledn Finger

(Includes PCI 32bit master x2, USBx1, COMx1, PCIe1 Signal)

CHAPTER 3 BIOS SETUP

3.1 BIOS Introduction

The BIOS (Basic Input/Output System) installed in your computer system's ROM supports Intel processors. The BIOS provides critical low-level support for a standard device such as disk drives, serial ports and parallel ports. It also provides password protection as well as special support for detailed fine-tuning of the chipset controlling the entire system.

3.2 BIOS Setup

The BIOS provides a Setup utility program for specifying the system configurations and settings. The BIOS ROM of the system stores the Setup utility. When you turn on the computer, the BIOS is immediately activated. Pressing the key immediately allows you to enter the Setup utility. If you are a little bit late pressing the key, POST (Power On Self Test) will continue with its test routines, thus preventing you from invoking the Setup. If you still wish to enter Setup, restart the system by pressing the "Reset" button or simultaneously pressing the <Ctrl>, <Alt> and <Delete> keys. You can also restart by turning the system Off and back On again. The following message will appear on the screen:

```
Press <DEL> to Enter Setup
```

In general, you press the arrow keys to highlight items, <Enter> to select, the <PgUp> and <PgDn> keys to change entries, <F1> for help and <Esc> to quit.

When you enter the Setup utility, the Main Menu screen will appear on the screen. The Main Menu allows you to select from various setup functions and exit choices.

Warning: *It is strongly recommended that you avoid making any changes to the chipset defaults. These defaults have been carefully chosen by both AMI and your system manufacturer to provide the absolute maximum performance and reliability. Changing the defaults could cause the system to become unstable and crash in some cases.*

System Language

Choose the system default language.

System Date

Set the Date. Use Tab to switch between Data elements.

System Time

Set the Time. Use Tab to switch between Data elements.

3.3 Advanced Settings

This section allows you to configure and improve your system and allows you to set up some system features according to your preference.

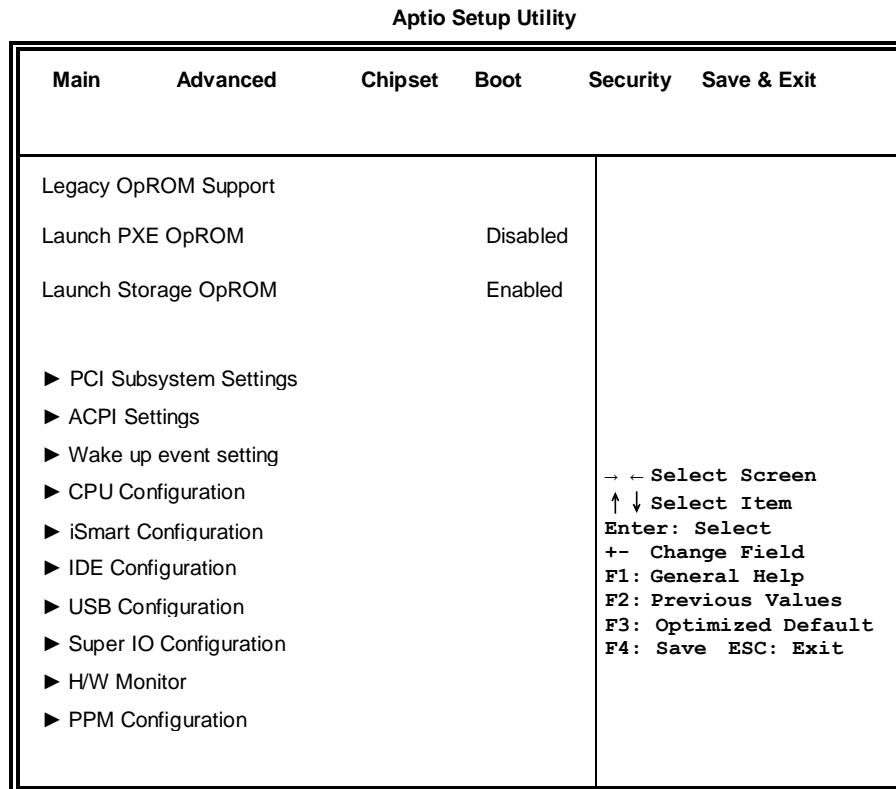

Launch PXE OpROM

Enable or Disable Boot Option for Legacy Network Devices.

Launch Storage OpROM

Enable or Disable Boot Option for Legacy Mass Storage Devices with Option ROM.

PCI Subsystem Settings

Aptio Setup Utility					
Main	Advanced	Chipset	Boot	Security	Save & Exit
PCI Bus Driver Version			V 2.05.01		
PCI ROM Priority			Legacy ROM		
PCI Common Settings					→ ← Select Screen
PCI Latency Timer			32 PCI Bus Clocks		↑ ↓ Select Item
VGA Palette Snoop			Disabled		Enter: Select
PERR# Generation			Disabled		+ - Change Field
SERR# Generation			Disabled		F1: General Help
					F2: Previous Values
					F3: Optimized Default
					F4: Save ESC: Exit

PCI ROM Priority

In case of multiple Option ROMs (Legacy and EFI Compatible), specifies what PCI Option ROM to launch.

PCI Latency Timer

Value to be programmed into PCI Latency Timer Register.

VGA Palette Snoop

Enables or Disables VGA Palette Registers Snooping.

PERR# Generation

Enables or Disables PCI Device to Generate PERR#.

SERR# Generation

Enables or Disables PCI Device to Generate SERR#.

ACPI Settings

Aptio Setup Utility					
Main	Advanced	Chipset	Boot	Security	Save & Exit
Enable ACPI Auto Configuration			Disabled		→ ← Select Screen ↑ ↓ Select Item Enter: Select +- Change Field F1: General Help F2: Previous Values F3: Optimized Default F4: Save ESC: Exit
Enable Hibernation			Enabled		
ACPI Sleep State			S1 (CPU Stop Clock)		
S3 Video Report			Disabled		

Enabled ACPI Auto Configuration

Enables or Disables BIOS ACPI Auto Configuration.

Enable Hibernation

Enables or Disables System ability to Hibernate (OS/S4 Sleep State). This option may be not effective with some OS.

ACPI Sleep State

Select the highest ACPI sleep state the system will enter, when the SUSPEND button is pressed.

S3 Video Report

The default setting is Disabled.

Wake up event settings

Aptio Setup Utility					
Main	Advanced	Chipset	Boot	Security	Save & Exit
Wake on Ring		Disabled			
Wake on PCI PME		Disabled			
Wake on PCIE PME		Disabled			
				→ ← Select Screen ↑ ↓ Select Item Enter: Select +- Change Field F1: General Help F2: Previous Values F3: Optimized Default F4: Save ESC: Exit	

Wake on Ring

The options are Disabled and Enabled.

Wake on PCI PME

The options are Disabled and Enabled.

Wake on PCIE PME

The options are Disabled and Enabled.

CPU Configuration

This section shows the CPU configuration parameters.

Aptio Setup Utility					
Main	Advanced	Chipset	Boot	Security	Save & Exit
CPU Configuration					
Processor Type			Intel(R) Atom(TM) CPU		
EMT64			Not Supported		
Processor Speed			2132 MHz		
System Bus Speed			533 MHz		
Ratio Status			16		
Actual Ratio			16		
System Bus Speed			533 MHz		
Processor Stepping			30661		
Microcode Revision			262		
L1 Cache RAM			2x56 k		
L2 Cache RAM			2x512 k		
Processor Core			Dual		→ ← Select Screen
Hyper-Threading			Supported		↑ ↓ Select Item
					Enter: Select
					+ - Change Field
					F1: General Help
					F2: Previous Values
					F3: Optimized
					Default
					F4: Save ESC: Exit
Hyper-Threading			Enabled		
Execute Disable Bit			Enabled		
Limit CPUID Maximum			Disabled		

Hyper-threading

Enabled for Windows XP and Linux (OS optimized for Hyper-Threading Technology) and Disabled for other OS (OS not optimized for Hyper-Threading Technology). When Disabled, only one thread per enabled core is enabled.

Execute Disable Bit

XD can prevent certain classes of malicious buffer overflow attacks when combined with a supporting OS (Windows Server 2003 SP1, Windows XP SP2, SuSE Linux 9.2, Re33dHat Enterprise 3 Update 3.)

Limit CPUID Maximum

Disabled for Windows XP.

iSmart Controller

Aptio Setup Utility					
Main	Advanced	Chipset	Boot	Security	Save & Exit
iSmart Controller					
EuP/ErP standby power Control Keep standby power					
Power-On after Power failure		Disabled		→ ← Select Screen ↑ ↓ Select Item Enter: Select +- Change Field F1: General Help F2: Previous Values F3: Optimized Default F4: Save ESC: Exit	
Schedule Slot 1		None			
Schedule Slot 2		None			

EuP/ErP standby power Control

Saving the power consumption on power off.

Power-On after Power failure

This field sets the system power status whether on or off when power returns to the system from a power failure situation.

Schedule Slot

None / Power On / Power On/Off – Setup the hour/minute for system power on

IDE Configuration

Aptio Setup Utility					
Main	Advanced	Chipset	Boot	Security	Save & Exit
SATA Port0		Not Present			
SATA Port1		Not Present			
SATA Controller(s)		Enabled			
Configure SATA as		IDE			
				→ ← Select Screen ↑ ↓ Select Item Enter: Select +- Change Field F1: General Help F2: Previous Values F3: Optimized Default F4: Save ESC: Exit	

SATA Controller(s)

Enable / Disable Serial ATA Controller.

Configure SATA as

- (1) IDE Mode.
- (2) AHCI Mode.

USB Configuration

Aptio Setup Utility							
Main	Advanced	Chipset	Boot	Security	Save & Exit		
USB Configuration							
USB Devices: None							
Legacy USB Support		Enabled		→ ← Select Screen ↑ ↓ Select Item Enter: Select +- Change Field F1: General Help F2: Previous Values F3: Optimized Default F4: Save ESC: Exit			
EHCI Hand-off		Enabled					
USB hardware delays and time-outs:							
USB Transfer time-out		20 sec					
Device reset time-out		20 sec					
Device power-up delay		AUTO					

Legacy USB Support

Enables Legacy USB support.

AUTO option disables legacy support if no USB devices are connected.

DISABLE option will keep USB devices available only for EFI applications.

EHCI Hand-off

Enabled/Disabled. This is a workaround for OSeS without EHCI hand-off support. The EHCI ownership change should be claimed by EHCI driver.

USB Transfer time-out

The time-out value for Control, Bulk, and Interrupt transfers.

Device reset time-out

USB mass Storage device start Unit command time-out.

Device power-up delay

Maximum time the device will take before it properly reports itself to the Host Controller. 'Auto' uses default value: for a Root port it is 100ms, for a Hub port the delay is taken from Hub descriptor.

Super IO Configuration

Aptio Setup Utility					
Main	Advanced	Chipset	Boot	Security	Save & Exit
W83627UHG Super IO Configuration					
Super IO Chip		Winbond W83627UHG		→ ← Select Screen ↑ ↓ Select Item Enter: Select +- Change Field F1: General Help F2: Previous Values F3: Optimized Default F4: Save ESC: Exit	
▶ W83627UHG Serial Port 0 Configuration					
▶ W83627UHG Serial Port 1 Configuration					

Serial Port Configuration

Set Parameters of Serial Ports. User can Enable/Disable the serial port and Select an optimal settings for the Super IO Device.

H/W Monitor

Aptio Setup Utility					
Main	Advanced	Chipset	Boot	Security	Save & Exit
System temperature		+33 C		→ ← Select Screen ↑ ↓ Select Item Enter: Select +- Change Field F1: General Help F2: Previous Values F3: Optimized Default F4: Save ESC: Exit	
CPU temperature		+57 C			
VCORE		+1.192 V			
+12V		+11.230 V			
+3.3V		+3.312 V			
AVCC		+4.832 V			
CPU Shutdown Temperature		Disabled			

CPU Smart Fan Control

Disabled (default)

70 °C / 75 °C / 80 °C / 85 °C / 90 °C / 95 °C

Temperatures/Voltages

These fields are the parameters of the hardware monitoring function feature of the motherboard. The values are read-only values as monitored by the system and show the PC health status.

CPU Shutdown Temperature

The default setting is Disabled.

PPM Configuration

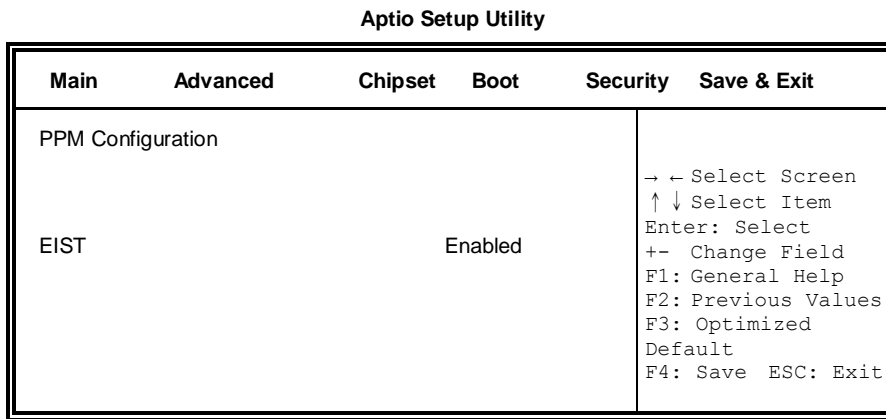

3.4 Chipset Settings

This section allows you to configure and improve your system and allows you to set up some system features according to your preference.

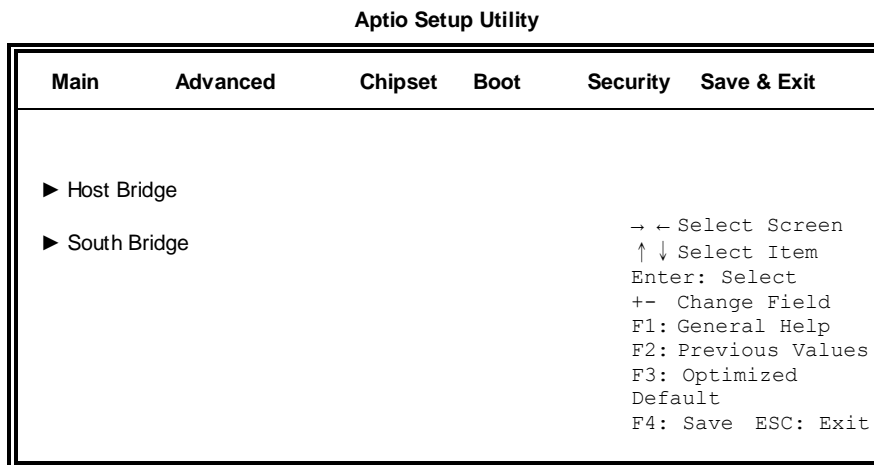

Host Bridge

This item shows the Host Bridge Parameters.

South Bridge

This item shows the South Bridge Parameters.

Host Bridge

This section allows you to configure the Host Bridge Chipset.

Aptio Setup Utility					
Main	Advanced	Chipset	Boot	Security	Save & Exit
<ul style="list-style-type: none"> ▶ Memory Frequency and Timing ▶ Intel IGD Configuration 					
*****Memory Information*****					
Memory Frequency			1067 MHz(DDR3)		
Total Memory			2048 MB		
DIMM#1			2048 MB		
			→ ← Select Screen ↑ ↓ Select Item Enter: Select +- Change Field F1: General Help F2: Previous Values F3: Optimized Default F4: Save ESC: Exit		

Memory Frequency and Timing

Aptio Setup Utility					
Main	Advanced	Chipset	Boot	Security	Save & Exit
Memory Frequency and Timing					
MRC Fast Boot			Enabled		
			→ ← Select Screen ↑ ↓ Select Item Enter: Select +- Change Field F1: General Help F2: Previous Values F3: Optimized Default F4: Save & Exit ESC: Exit		

MRC Fast Boot

The options are Disabled and Enabled.

Intel IGD Configuration

Aptio Setup Utility					
Main	Advanced	Chipset	Boot	Security	Save & Exit
Intel IGD Configuration					→ ← Select Screen ↑ ↓ Select Item Enter: Select +- Change Field F1: General Help F2: Previous Values F3: Optimized Default F4: Save & Exit ESC: Exit
IGFX-Boot Type		VBIOS Default			
LCD Panel Type		1024x768 LVDS			
Panel Scaling		Auto			
Active LFP		Int-LVDS			

IGFX-Boot Type

Select the video Device which will be activated during POST .

Panel Color Depth

Select the LFP Panel Color Depth: 18 Bit, 24 Bit.

LCD Panel Type

Select LCD panel used by Internal Graphics Device by selecting the appropriate setup item: 640x480 LVDS ~ 2048x1536 LVDS.

Panel Scaling

Select the LCD panel scaling option used by the Internal Graphics Device: Auto, Off, Force Scaling.

Active LFP

Select the Active LFP Configuration.

No LVDS: VBIOS does not enable LVDS.

Int-LVDS: VBIOS enables LVDS driver by Integrated encoder.

South Bridge

This section allows you to configure the South Bridge Chipset.

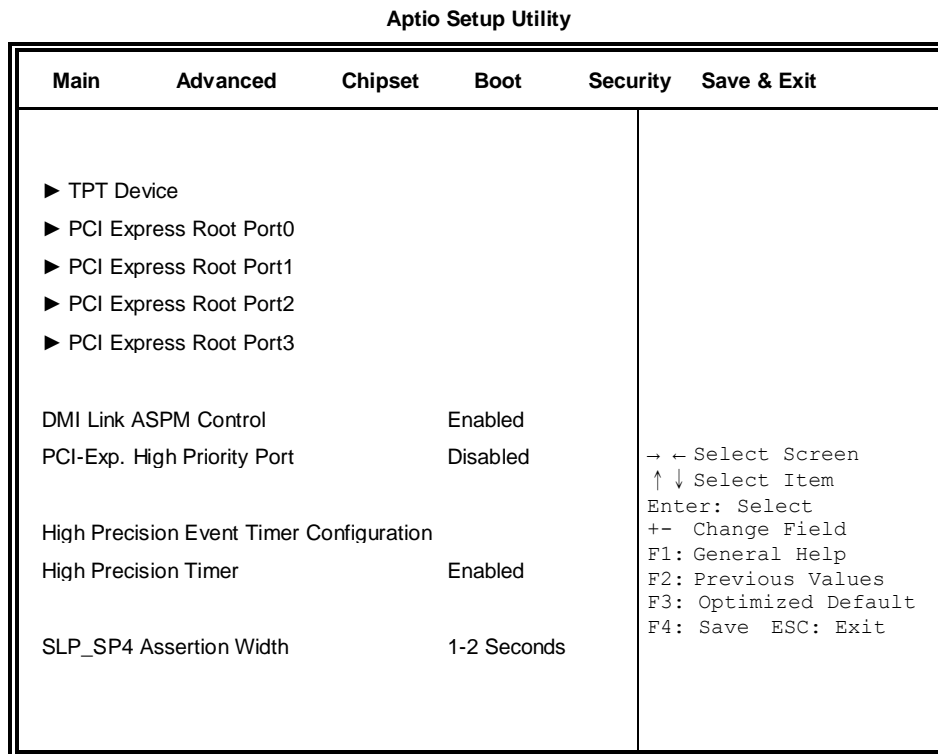

DMI Clink ASPM Control

The control of Active State Power Management on both NB side and SB side of the DMI Link.

PCI-Exp. High Priority Port

The options are Disabled, Port1, Port2, Port3, and Port4.

High Precision Event Timer Configuration

Enable/or Disable the High Precision Event Timer.

SLP_S4 Assertion Stretch Enable

Select a minimum assertion width of the SLP_S4# signal.

TPT Device

Aptio Setup Utility

Main	Advanced	Chipset	Boot	Security	Save & Exit
Azalia Controller			HD Audio		
UHCI #1 (port 0 and 1)			Enabled	→ ← Select Screen ↑ ↓ Select Item Enter: Select +- Change Field F1: General Help F2: Previous Values F3: Optimized Default F4: Save ESC: Exit	
UHCI #2 (port 2 and 3)			Enabled		
UHCI #3 (port 4 and 5)			Enabled		
UHCI #4 (port 6 and 7)			Enabled		
USB 2.0(UHCI) Support			Enabled		

PCI Express Root Port0

Aptio Setup Utility

Main	Advanced	Chipset	Boot	Security	Save & Exit
PCI Express Port 0			Enabled	→ ← Select Screen ↑ ↓ Select Item Enter: Select +- Change Field F1: General Help F2: Previous Values F3: Optimized Default F4: Save ESC: Exit	
Port 0 IOxAPIC			Disabled		
Automatic ASPM			Manual		

PCI Express Root Port1

Aptio Setup Utility

Main	Advanced	Chipset	Boot	Security	Save & Exit
PCI Express Port 1		Auto	→ ← Select Screen ↑ ↓ Select Item Enter: Select +- Change Field F1: General Help F2: Previous Values F3: Optimized Default F4: Save ESC: Exit		
Port 0 IOxAPIC		Disabled			
Automatic ASPM		Auto			

PCI Express Root Port2

Aptio Setup Utility

Main	Advanced	Chipset	Boot	Security	Save & Exit
PCI Express Port 2		Auto			
Port 0 IOxAPIC		Disabled			
Automatic ASPM		Auto			
				→ ← Select Screen ↑ ↓ Select Item Enter: Select +- Change Field F1: General Help F2: Previous Values F3: Optimized Default F4: Save ESC: Exit	

PCI Express Root Port3

Aptio Setup Utility

Main	Advanced	Chipset	Boot	Security	Save & Exit
PCI Express Port 3		Enabled			
Port 0 IOxAPIC		Disabled			
Automatic ASPM		Auto			
				→ ← Select Screen ↑ ↓ Select Item Enter: Select +- Change Field F1: General Help F2: Previous Values F3: Optimized Default F4: Save ESC: Exit	

Boot Settings

Aptio Setup Utility					
Main	Advanced	Chipset	Boot	Security	Save & Exit
Boot Configuration					
Setup Prompt Timeout			1		
Bootup NumLock State			On		
Quiet Boot			Disabled		
Fast Boot			Disabled		
CSM16 Module Version			07.68		
GateA20 Active			Upon Request		→ ← Select Screen
Option ROM Messages			Force BIOS		↑ ↓ Select Item
Interrupt 19 Canture			Disabled		Enter: Select
CSM Support			Enabled		+ - Change Field
Boot Option Priorities					F1: General Help
					F2: Previous Values
					F3: Optimized Default
					F4: Save ESC: Exit

Setup Prompt Timeout

Number of seconds to wait for setup activation key. 65535(0xFFFF) means indefinite waiting.

Bootup NumLock State

Select the keyboard NumLock state.

Quiet Boot

Enables/Disables Quiet Boot option.

Fast Boot

Enables/Disables boot with initialization of a minimal set of devices required to launch active boot option. Has no effect for BBS boot options.

GateA20 Active

UPON REQUEST – GA20 can be disabled using BIOS services.

ALWAYS – do not allow disabling GA20.

Option ROM Messages

Set display mode for Option ROM. Options: Force BIOS and Keep Current.

Interrupt 19 Capture

Enable: Allows Option ROMs to trap Int 19.

CSM Support

Enables/Disables/Auto CSM Support.

Boot Option Priorities

Sets the system boot order.

3.5 Security Settings

This section allows you to configure and improve your system and allows you to set up some system features according to your preference.

Aptio Setup Utility					
Main	Advanced	Chipset	Boot	Security	Save & Exit
Password Description If ONLY the Administrator's password is set, then this only limits access to Setup and is only asked for when entering Setup. If ONLY the User's password is set, then this is a power on password and must be entered to boot or enter Setup. In Setup the User will have Administrator rights Administrator Password User Password		→ ← Select Screen ↑ ↓ Select Item Enter: Select +- Change Field F1: General Help F2: Previous Values F3: Optimized Default F4: Save ESC: Exit			

Administrator Password

Set Setup Administrator Password.

User Password

Set User Password.

3.6 Save & Exit Settings

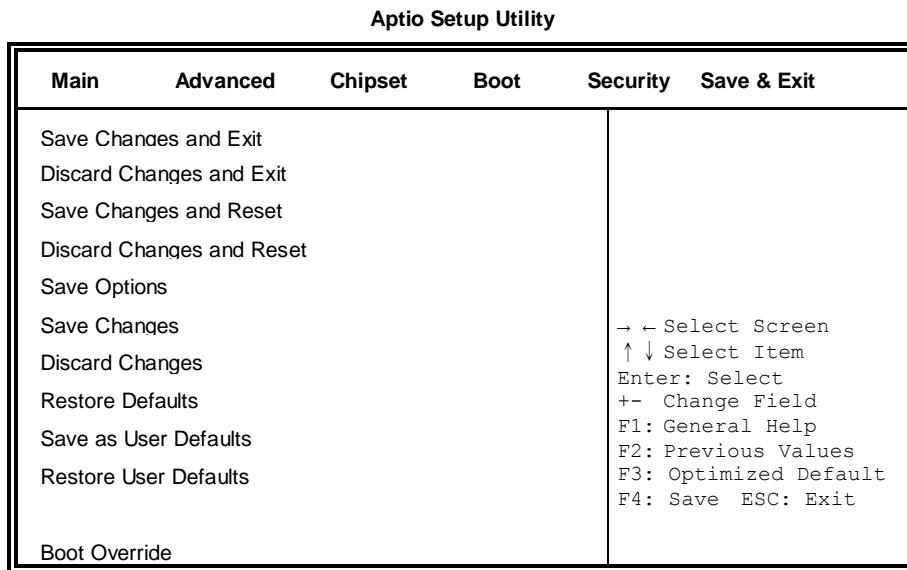

Save Changes and Exit

Exit system setup after saving the changes.

Discard Changes and Exit

Exit system setup without saving any changes.

Save Changes and Reset

Reset the system after saving the changes.

Discard Changes and Reset

Reset system setup without saving any changes.

Save Changes

Save Changes done so far to any of the setup options.

Discard Changes

Discard Changes done so far to any of the setup options.

Restore Defaults

Restore/Load Defaults values for all the setup options.

Save as User Defaults

Save the changes done so far as User Defaults.

Restore User Defaults

Restore the User Defaults to all the setup options.

Boot Override

Pressing ENTER causes the system to enter the OS.

CHAPTER 4 DRIVERS INSTALLATION

This section describes the installation procedures for software and drivers. The software and drivers are included with the motherboard.

IMPORTANT NOTE:

After installing your Windows operating system, you must install first the Intel Chipset Software Installation Utility before proceeding with the drivers installation.

4.1 Intel Chipset Software Installation Utility

The Intel Chipset Drivers should be installed first before the software drivers to enable Plug & Play INF support for Intel chipset components. Follow the instructions below to complete the installation.

1. Insert the disc that comes with the board. Click **Intel** and then **Intel(R) Cedarview Chipset Drivers**.



2. Click **Intel(R) Chipset Software Installation Utility**.



3. When the Welcome screen to the Intel® Chipset Device Software appears, click **Next** to continue. Click **Yes** to accept the software license agreement and proceed with the installation process.
4. On the Readme File Information screen, click **Next** to continue the installation.
5. The Setup process is now complete. Click **Finish** to restart the computer and for changes to take effect.

4.2 VGA Drivers Installation

1. Click **Intel(R) Cedarview Graphics Driver**.



2. When the Welcome screen appears, click **Next** to continue.



4. Click **Yes** to agree with the license agreement and continue the installation.

5. On the Readme File Information screen, click **Next** to continue the installation of the Intel® Graphics Media Accelerator Driver.

6. On Setup Progress screen, click **Next** to continue.

7. Setup complete. Click **Finish** to restart the computer and for changes to take effect.

4.3 Realtek HD Audio Driver Installation

1. Click *Realtek High Definition Audio Driver*.



2. On the Welcome to the InstallShield Wizard screen, click **Next** to proceed with and complete the installation process.

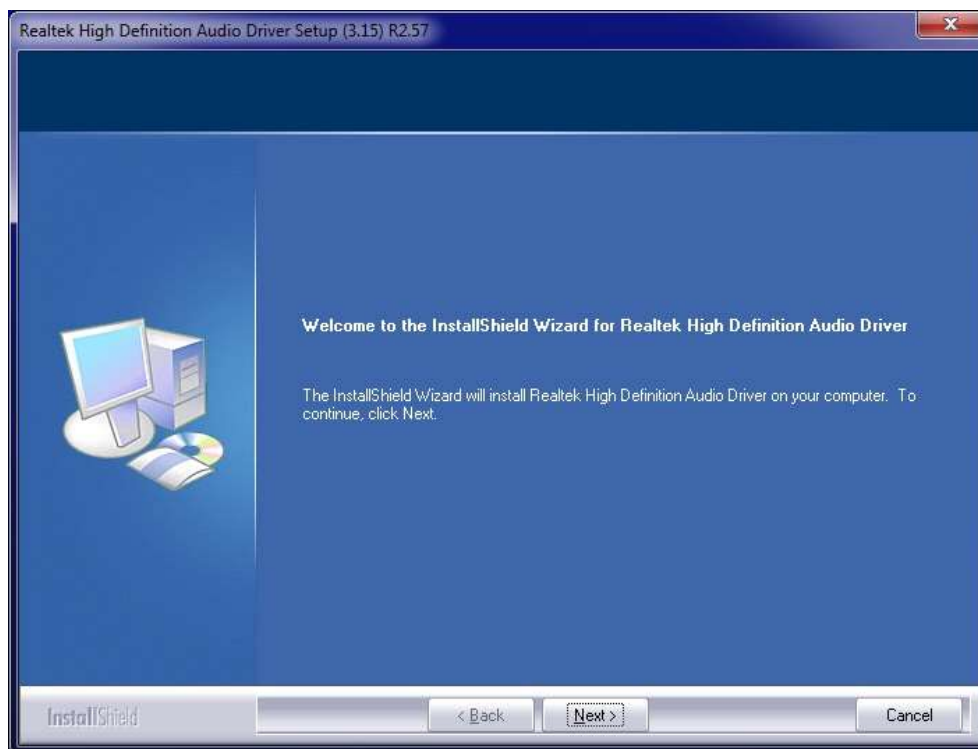

4. Restart the computer when prompted.

4.4 LAN Drivers Installation

1. Click **Realtek LAN Controller Driver**.



2. Click **Next** to proceed with and complete the installation process.

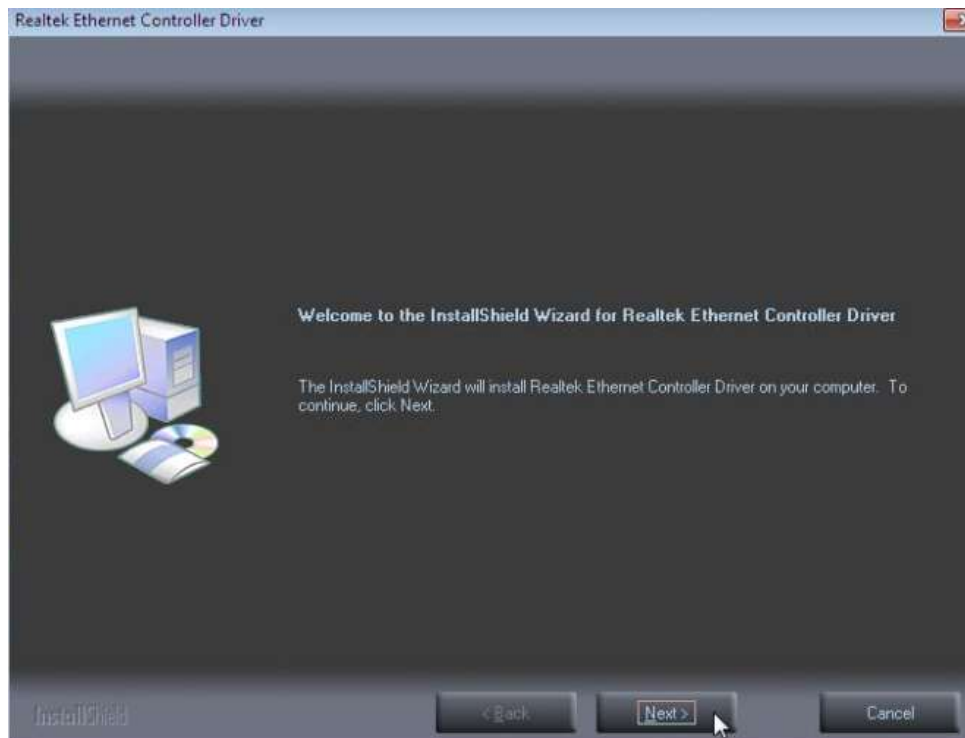

3. The wizard is ready to begin installation. Click **Install** to begin the installation.

4. When setup is complete, click **Finish** to restart the computer and for changes to take effect.

4.5 ALTERA FPGA Driver Installation

1. Insert the drivers DVD into the DVD drive. Click **Intel** and then **ALTERA FPGA Driver**.



2. When the Welcome to Peripheral Controller Driver 2.0 for Windows XP/Vista Setup Wizard screen appears, click **Next** to continue.

3. When the Ready to Install screen appears, click **Install** to continue.

4. The Setup process is now complete, Click **Finish** to restart the computer.